

Analysis of high efficiency membrane pilot testing for membrane design optimisation

F.A. Leon*, A. Ramos

Instituto Universitario de Sistemas Inteligentes y Aplicaciones Numéricas en Ingeniería, Universidad de las Palmas de Gran Canaria, de Tafira Baja, 35017 Las Palmas de Gran Canaria, Spain, Tel. +34686169516, email: federico.leon@ulpgc.es (F.A. Leon), alejandro.ramos@ulpgc.es (A. Ramos)

Received 6 July 2016; Accepted 10 February 2017

ABSTRACT

The construction of the new seawater intake at reverse osmosis desalination plant located in Almería (Spain) finished on May 2011. From this moment, the water catchment was located at 35 m depth instead of the 14 m depth of the former intake. The most significant outcome has been a new thermal scenario with lower maximum temperatures and more stable in time. Because of the lower maximum temperatures while the minimum temperatures remain the same, the pressure for water quality requirements accomplishment at high temperatures have decreased. Therefore new design and operation development opportunities have appeared. Taking into account that membrane replacement and retrofit projects are about to come at this desalination plant, and under this new thermal scenario, a pilot test has been developed. On the one hand, the purpose of this study was to compare the performance of the different membranes manufacturers and on the other hand, to determine the optimal membrane configuration and operation conditions able to achieve water quality and quantity needs under the new thermal intake conditions by the design of a pilot test. The best option has been determined taking into account investment versus operation (energy) costs.

Keywords: Membrane design optimization; Seawater reverse osmosis desalination

1. Introduction

Regarding the studies of other authors about energy performance of a reverse osmosis (RO) desalination plant operating with variable pressure [1–12], about desalination efficiency in their different recent articles, we continued working in this way researching in a real full-scale seawater reverse osmosis (SWRO) desalination plant following the items below, thanks to the information comparted with Acuamed.

The objective of this study is the design of a pilot test for monitoring the modification in the seawater intake of a production plant. Thanks to this improvement, it is tried to get the minimum energy consumption costs for the operation of a SWRO desalination plant. The performance of different membranes of three manufacturers are compared in order to determine the water quality, under this new thermal sce-

nario, from the analysis of the electrical conductivity and temperature, mainly.

Fig. 1 displays the new thermal scenario, more stable since seawater catchment changed from 35 m depth to 14 m depth of the former intake.

2. Results of the new seawater intake

After this new seawater intake construction, temperatures are more stable; the feed pressure decreased 2–3 bar therefore the electrical consumption too. The energetic efficiency is one of the highest concerning issues since the energy prize had risen over 25% in the last 10 years in Spain, and it represents over 50% of the operational costs of a desalination plant. Besides best practices in energy contracting have been applied in order to minimize the energy cost acquisition, any significant specific consump-

*Corresponding author.

Presented at the EDS conference on Desalination for the Environment: Clean Water and Energy, Rome, Italy, 22–26 May 2016.

tion reduction would lead to important economic savings. Therefore, the design of the optimal membrane configuration is a key factor for the energetic efficiency of the desalination plant.

The interest of the work is to design a pilot testing order to compare the performance of the different membranes models, under this thermal scenario, and to determine the main contributions applicable to all desalination plants with the most profitable configuration to get more water quality and quantity at the minimum energy consumption.

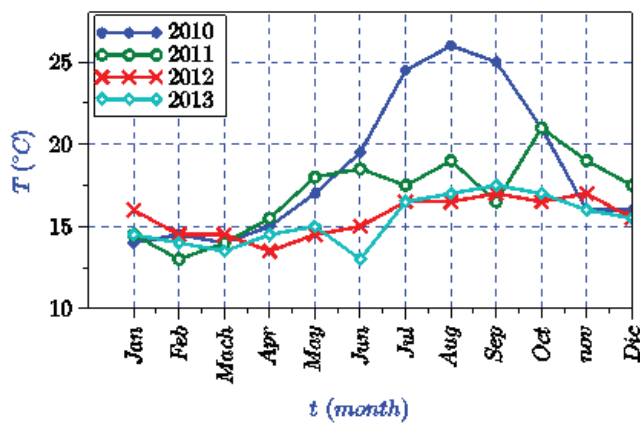

Fig. 1. Monthly raw seawater average temperatures from 2011 to 2013.

Because of the lower maximum temperatures (minimum temperatures remain the same) the pressure for water quality requirements accomplishment at high temperatures decreased. Therefore new design and operation opportunities appeared. Taking into account that membrane replacement and retrofit projects are about to come at this desalination plant, and under this new thermal scenario, a pilot test has been developed. Due to this pilot test, the energy consumption due to this high efficiency membrane test is reduced.

On the other hand, to determine the optimal membrane configuration and operation conditions able to achieve water quality and quantity needs under the new thermal intake conditions. The best option has to be determined by taking into account investment versus operation and energy costs.

3. Pilot test description

The pilot test developed consist of three aging HPV (high-pressure vessels) and a Test HPV.

3.1. Aging HPV description

Aging HPV consists of three high pressure vessels. The vessels are equipped with a control valve, a pressure transmitter and a flow meter in the permeate flow. Further instruments of the rack provided necessary information for the appropriate Aging HPV monitoring. The aim of the

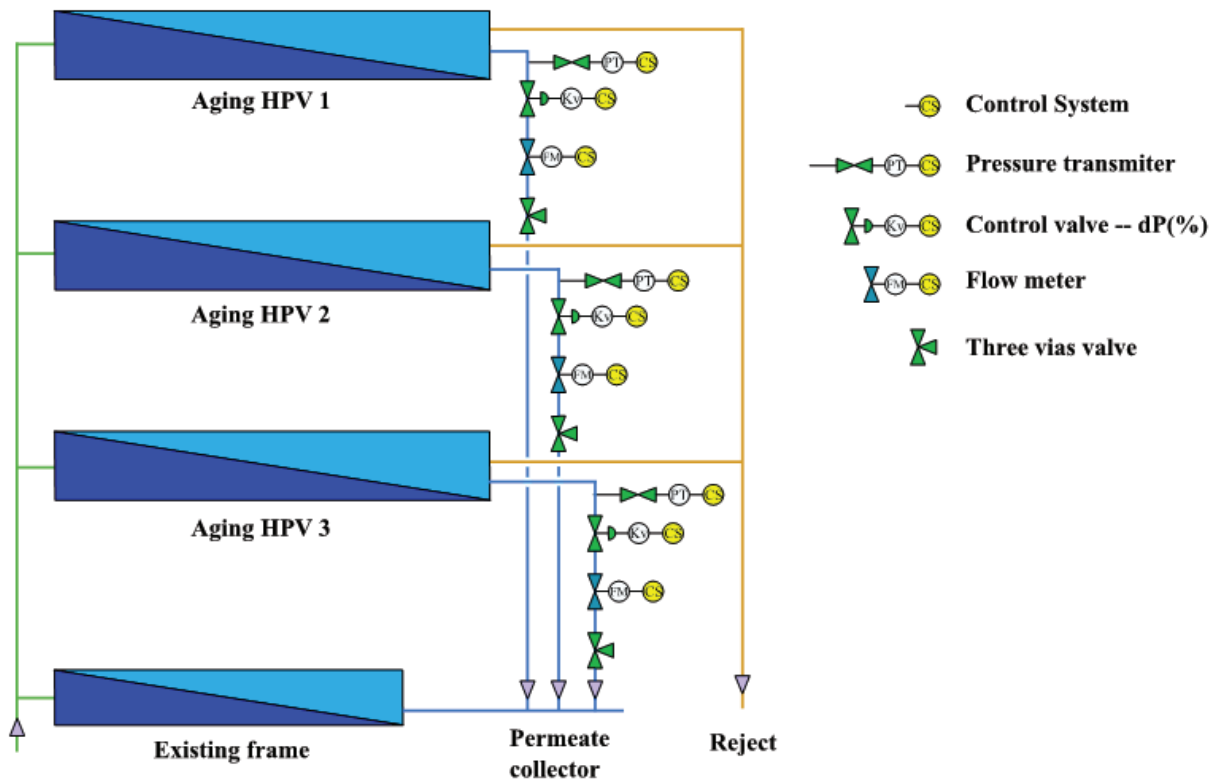

Fig. 2. Aging HPV diagram.

Aging HPV was to achieve a mature performance of the membranes, Fig. 2 displays the diagram of the Aging HPV. During this aging process, 2 months, the main performance parameters have been controlled.

The three pressure vessels (Aging HPV) are installed in parallel with the other vessels of the train. It is introduced the same feed flow and same feed pressure for all three pressure vessels.

3.1.1. Membranes

Membranes of three main manufacturers have been essayed (A, B, and C), details of membranes are displayed in Table 1.

Test conditions are the following: feed water pressure 800 psi (5.52 MPa), feed water temperature 77°F (25°C), feed water concentration 32,000 mg/l NaCl, recovery rate 8%, feed water pH 8. Membrane manufactures are Toray, LG and Dow. Elements are similar to standard ones but with a special design and configuration for this pilot.

Operation limits are the following: maximum operation pressure 1200 psi (8.3 MPa), maximum feed water temperature 113°F (45°C), maximum feed water SDI₁₅ 5, feed water chlorine concentration not detectable, feed water pH range, continuous operation 2–11, feed water pH range, chemical cleaning 1–12, maximum pressure drop element 20 psi (0.14 MPa) and maximum pressure drop per vessel 60 psi (0.4 MPa).

As displayed in Table 1, membranes of the C-model have been installed in a hybrid configuration, with seven elements equipped with four of R-440 model and with three of X-440 model, seven elements with membranes of the A-model, and finally seven elements with membranes of the B-model. These membranes have been used for Aging HPV and Test HPV.

Feed water comes from the new open intake, with temperatures more stable between 13°C and 19°C, improving the energy consumption of the installation. Feed quality is the following: Ca 581.3 mg/l, Mg 1435.6 mg/l, Na 13,261.5 mg/l, K 443.0 mg/l, NH₄ 0.2 mg/l, Sr 8.9 mg/l, Cl 21,054.5 mg/l, SO₄ 2,907.5 mg/l, HCO₃ 127.7 mg/l, SiO₂ 3.8 mg/l, B 4.7 mg/l, Br 68.02 mg/l and PO₄ 0.2 mg/l. Total feed TDS is 39,898.0 mg/l, feed conductivity 52,825.2 uS/cm and pH value 7.3. It is shown more detail information of the permeate water quality, real experimental results and operating data in the item 4 of this article.

3.1.2. Methodology of aging HPV and instrumentation

In order to test the three aging pressure vessels it is fixed the same feed pressure for each vessel, therefore is expected different permeate flow for the three vessels.

Due to this all three aging pressure vessels have installed a control valve for the Delta Pressure, together a pressure transmitter, flow meter, control system and three valves, in the permeate pipe (Fig. 2). This is under low pressure so it is not a big cost for the investigation.

It must be fixed the same permeate flow per aging vessel, and this is possible with a back pressure. In this way, the aging pressure vessel with the highest permeate pressure is the one with the lowest energy consumption. It is needed more back pressure in order to get the same permeate flow of the others. In this way, it is possible to determine the most efficient type of reverse osmosis membranes. If all the vessels of the trains had this condition, with this type of membrane of the highest back pressure, it would be possible to operate with higher feed pressure than now, saving energy costs, or producing more water at the same feed pressure than now.

Therefore, with this study, it is achieved the most efficient reverse osmosis membrane, under these operating conditions of the plant.

3.2. Test HPV description

Test HPV consists of a vessel equipped with all the required elements in order to a full monitoring and control of the operational conditions (pressure and flows of the seawater, brine and permeate flows).

The Test HPV was equipped with:

- Feed seawater flow:
 - a control valve at the HPV inlet for the water flow and pressure control,
 - a pressure transmitter,
 - a drop pressure transmitter,
- Permeate flow:
 - a flow meter,
 - a pressure transmitter (the one of the full scale rack),
- Brine flow:
 - three valves, in order to control the brine flow and appropriately make the brine discharge from 65 bars to atmospheric pressure.
 - a flowmeter.

Table 1
Details of membranes

	Number of elements	Membrane area ft ² (m ²)	Feed spacer thickness mil	Diameter inch	Aver. flow m ³ /d	Aver. boron rejection at pH 8 %	Aver. TDS rejection %
A-model							
R-440	7	440 (41)	28	8"	33.2	95	99.85
B-model							
440-R	7	440 (41)	28	8"	36.9	93	99.78
C-model							
R-440	4	440 (41)	28	8"	24.8	89	99.85
X440	3	440 (41)	28	8"	35.4	93	99.63

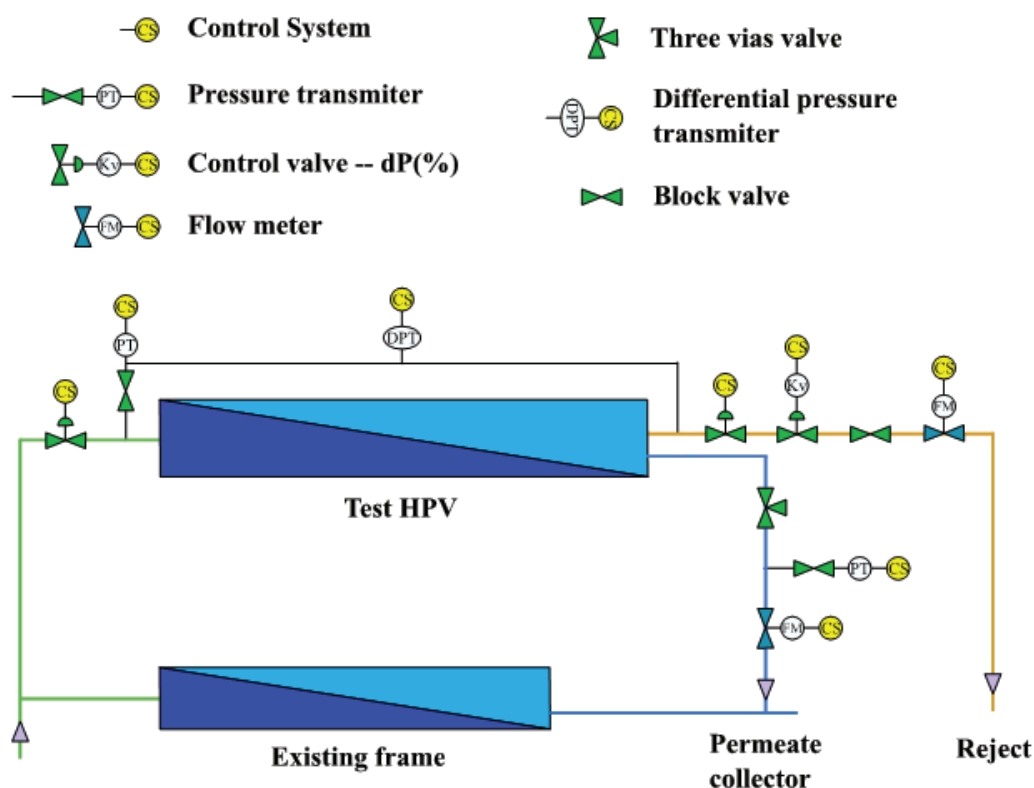

Fig. 3. Test HPV diagram.

For the test HPV the feed flow was calculated by summing up brine and permeate flows.

The Test HPV was designed in order to make it possible to test the three membrane types, each one from each manufacturer, under any condition. Test HPV diagram is shown in the Fig. 3. Any operation parameter (pressure or flow) could be modified by the control valves, and every main parameter (pressure, flows and water quality) could be measured.

The membranes tested, to determine its performance, have been subjected to the same operating conditions (pressure, flow, temperature).

Also, it has been installed at the permeate pipe: a flow meter, a pressure transmitter, and a three way valve. Moreover, it has been installed instruments in the brine pipe (three valves and a flow meter) and in the feed pipe (pressure transmitter, drop pressure transmitter and a control valve for the pressure and water flow control).

Under these conditions, it is possible to test the three different models of reverse osmosis membranes under real conditions, changing the feed pressure or feed flow, in order to get a permeate flow and also varying the recovery of the system. After this pilot test and with the information of the aging vessels, it can be obtained different schemas of the efficiency of each membrane, in order to select the most efficiency element.

Moreover, it must be taken into account the permeate quality for each type of membrane, because it must be produced water with TDS lower than 400 mg/l, i.e. a range of values of conductivity (EC) between 572 $\mu\text{S}/\text{cm}$ and 800 $\mu\text{S}/\text{cm}$ depending on the Temperature [9], and with Boron

lower than 1 mg/l. It is very interesting to measure the conductivity in a reverse osmosis plant due to it is faithful reflection of the TDS. If all membranes are under these parameters, it is possible to select the most efficient one, which produces the nominal flow with lower energy consumption.

The whole process was monitored in a screen developed ad hoc in the SCADA of the full-scale plant.

3.3. Sequential methodology of aging HPV and test HPV

In order to gather the appropriate information, it has been established the analytical program, as displayed in Tables 2 and 3.

The experiments have been carried out according to this schedule:

- Two months in a row in the Aging HPV running the three HPV simultaneously. During this period, the membranes have been monitored and aged simultaneously and under the same conditions before being tested.
- Two weeks in a row in the Test HPV. The membranes of each manufacturer have been loaded and tested in the Test HPV in order to determine its performance under specific conditions. Results between different membranes manufacturers have been compared under the same experimental conditions (pressure, flow, temperature), as the experiments have been carried out alternatively in the Test HPV.

Table 2
Aging HPV analytical program

Aging Hpv analytical program				
Parameter	Feed	Permeate	Brine	Analysis frequency
Water flow	–*	✓	–*	Continuous (SCADA monitored)
Pressure	✓ (rack/HPV)	✓	✓	Continuous (SCADA monitored)
Quality				
SDI	✓			8 h
Temperature	✓	✓		Daily (labor)/continuous (SCADA monitored)
Conductivity	✓	✓	✓	Daily (labor)/continuous (SCADA monitored)
pH	✓	✓	✓	Daily (labor)/continuous (SCADA monitored)
Boron	✓	✓		Raw water: daily/permeate: weekly
Other (full scale plant analysis)	✓	✓	✓	Monthly

* Only average feed/brine rack average values available.

The loop two months aging/two weeks testing periods have been repeated during the whole pilot. A key aspect in the definition of the process was the hydraulic model and the election of the valves that would lead to an appropriate control of the system. Thus, a detailed study has been developed following the next steps:

1. Environment definition: definition of the operational criteria and main parameters values under extreme testing conditions,
2. Hydraulic study: according to the operational conditions needs a hydraulic study was developed.

In this study it has been designed the piping system. It has also been chosen the control valves in order to accomplish the control requirements of the pilot test.

4. Results and discussion

Fig. 4 displays results of the Aging HPV, comparing temperature (°C) and permeate conductivity (uS/cm) for the three RO elements testing. Feed pressure is 69.9 bar, with a deviation of 0.4 bar, operating during 151 d, and with a permeate flow fixed in 3.6 m³/h.

Table 3
Test HPV analytical program

Test Hpv analytical program				
Parameter	Feed	Permeate	Brine	Analysis frequency
Water flow	✓	✓	✓	Continuous (SCADA monitored)
Pressure	✓	✓	✓	Continuous (SCADA monitored). ΔP available
Quality				
SDI	✓			8 h
Temperature	✓	✓		Daily (labor)/continuous (SCADA monitored)
Conductivity	✓	✓	✓	Daily (labor)/continuous (SCADA monitored)
pH	✓	✓	✓	Daily (labor)/continuous (SCADA monitored)
Boron	✓	✓		Raw water: daily/permeate: weekly
Other (full scale plant analysis)	✓	-	✓	Monthly
HPV probing		✓		170 h (weekly)

Since the objective of the aging stage was just to acquire a mature performance of the membranes and since a limited control of the operation parameters was possible, results showed an approximate (but not accurate) view of membrane behavior. As shown in Fig. 4, the conductivity of the membranes of A-membranes was the lowest, followed by B-membranes and C-membranes (for homogeneous feed pressure, water quality and feed temperature conditions).

Fig. 5 displays results of the Aging HPV for the pressure vessel with A-membranes (lowest conductivity) and projection data, comparing also temperature (°C) and permeate conductivity (uS/cm) at the same feed pressure and permeate flow fixed. The results are even better than projection data, so we understand there is a safety factor including in the software. Permeate conductivity is a bit lower than projection data and both of them follow the same model increasing A-membranes permeate TDS with the temperature.

Fig. 6 displays results of the Testing HPV, comparing temperature (°C) and permeate conductivity (uS/cm) for the three RO elements testing with a permeate flow fixed in 4.05 m³/h.

As shown in Fig. 6, the conductivity of the membranes of A-membranes was the lowest, followed by B-membranes

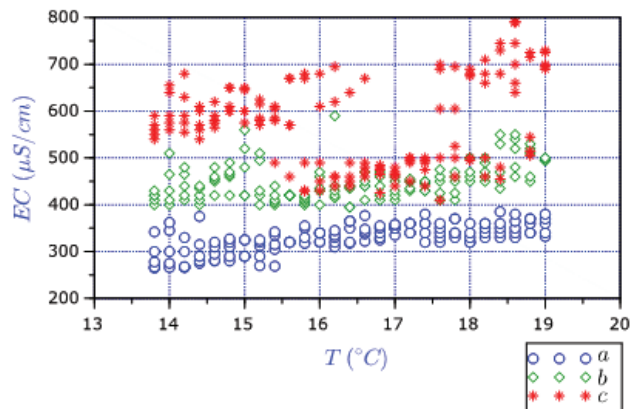

Fig. 4. Permeate conductivity during the aging stage. Comparing permeates conductivity (EC) with TDS [9] we have the following intervals:

Membrane a, EC [250 uS/cm, 400 uS/cm], TDS [125 mg/l, 280 mg/l]
 Membrane b, EC [400 uS/cm, 600 uS/cm], TDS [200 mg/l, 420 mg/l]
 Membrane c, EC [400 uS/cm, 800 uS/cm], TDS [200 mg/l, 560 mg/l]

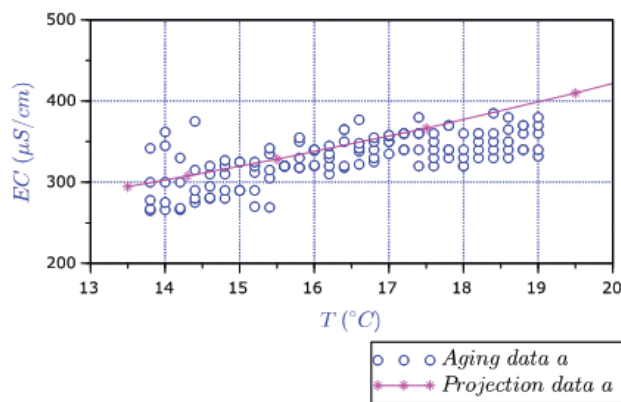

Fig. 5. A-membrane permeate conductivity during the aging stage and projection data.

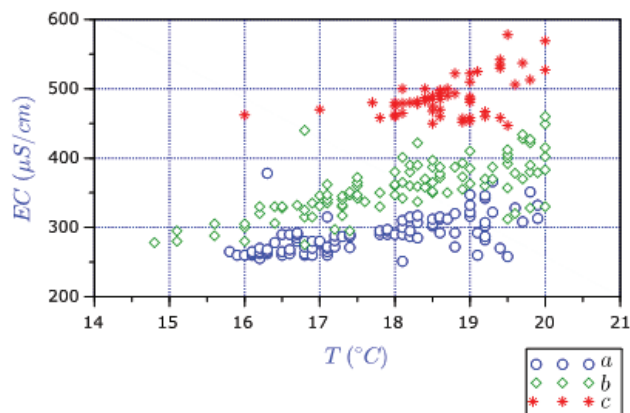

Fig. 6. Permeate conductivity during the Testing stage. Comparing permeates conductivity (EC) with TDS [9] we have the following intervals:

Membrane a, EC [250 uS/cm, 390 uS/cm], TDS [125 mg/l, 273 mg/l]
 Membrane b, EC [275 uS/cm, 460 uS/cm], TDS [138 mg/l, 322 mg/l]
 Membrane c, EC [440 uS/cm, 580 uS/cm], TDS [220 mg/l, 406 mg/l]

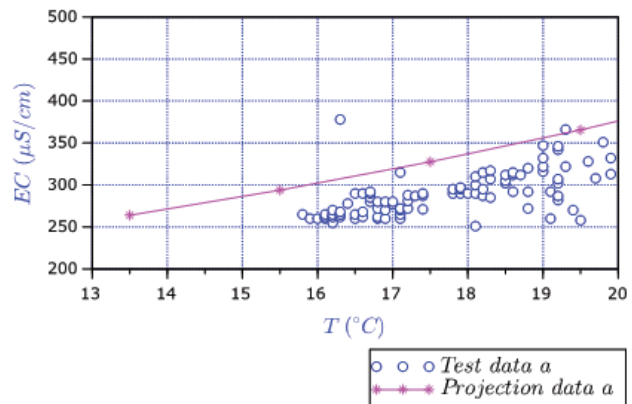

Fig. 7. A-membrane permeate conductivity during the testing stage and projection data.

(24% higher), and C-membranes (64% above B-membranes). Conductivity during Testing stage was lower than conductivity during Aging stage for the same temperature, as permeate set flow at Testing stage was higher.

Fig. 7 displays results of the Testing HPV for the pressure vessel with A-membranes (lowest conductivity) and projection data, comparing also temperature (°C) and permeate conductivity (uS/cm) at the fixed permeate flow of 4.05 m³/h. The results are again even better than projection data, permeate conductivity is lower than projection data.

Comparing results in the pilot test with other researchers [2,9], we can confirm that A-membranes are very efficient about permeate quality and TDS rejection with experimental data in between 125 mg/l and 273 mg/l, i.e. EC [250 uS/cm, 390 uS/cm]. B-membranes are also in a good position and C-membranes have a TDS a bit higher than the other elements before.

5. Conclusions

The conclusions of this pilot test will lead to compare the membrane performance of the three main membrane manufacturers, and to gather the required information to base future decision-making processes related to membrane replacement and retrofit projects with new membranes. In the case of membrane replacement, the pre-existing high-pressure pump already determines the operation conditions (pressure and water flow). Nevertheless, it is possible to evaluate the optimal number of HPV and the new membrane configuration for the rack. Under the perspective of retrofit projects, the operational conditions may be redefined. It is possible to adapt the high-pressure pump/electrical motor to the new operational needs, under the new thermal scenario. There is also the possibility to introduce VFD (variable frequency drives) to adequate pressure to temperature. Therefore the study of the most efficient operational conditions for each membrane manufacturer and configuration is a key factor in order to design the most adequate. In both cases (membrane replacement or retrofit projects), the pilot test may lead to reinforce the decision-making process with real data in order to choose the most efficient membrane and system configuration for

the new thermal scenario, taking into account investment versus energetic efficiency in each case: membrane replacement or retrofit project. The construction of the new seawater catchment at the desalination plant (from 14 to 35-m depth) changed the thermal scenario. While minimum temperatures stayed the same, maximum temperatures lowered. Hence, new opportunities for the membrane-system design appeared. Thus, a pilot test was developed in order to test the optimal membrane configuration able to fulfill quality and quantity needs with minimum energy consumption. The pilot test was defined into two phases: the Aging and the Testing stage. The Aging stage aimed at achieving a mature performance of the membranes. The Testing stage allowed a better control of the operational parameters, therefore, obtaining quality data to be analyzed. Results show a certain dispersion of data (especially related to those of feed pressure and correlation among normalized data) that may be corrected with the improvement of control elements (valves). An increase of boron results related to A-membranes membranes would be more appropriate; and it would be suitable to test C-membranes membranes at higher temperatures. Therefore, new resources would be required to continue the experiments. Nevertheless, results achieved the objectives of the study: to compare the performance and to determine the optimal membrane configuration. According to the results, A-membranes were the most efficient membranes (with 59.6 bar required to produce 4.05 m³/h in a seven element HPV at 20°C range), followed by B-membranes membranes (with pressure requirements 2% higher) and C-membranes membranes (with pressure requirements 3% above A-membranes). When talking about permeate quality, A-membranes membranes offered the lowest salinity (152 µS/cm normalized conductivity), followed by B-membranes (37% more salinity) and C-membranes (74% above A-membranes). In contrast to this, B-membranes produced permeate with a lower boron concentration (0.8 mg/l at 18°C range), followed by A-membranes membranes (21% above B-membranes) and C-membranes (39% above B-membranes).

References

- [1] D. Song, Y. Wang, S. Xu, J. Gao, Y. Ren, S. Wang, Analysis, experiment and application of a power-saving actuator applied in the piston type energy recovery device, *Desalination*, 361 (2015) 65–71.
- [2] E. Dimitriou, E. Mohamed, C. Karavas, G. Papadakis, Experimental comparison of the performance of two reverse osmosis desalination units equipped with different energy recovery devices, *Desal. Water Treat.*, 55 (2015) 3019–3026.
- [3] E. Dimitriou, E. Mohamed, G. Kyriakarakos, G. Papadakis, Experimental investigation of the performance of a reverse osmosis desalination unit under full-and part-load operation, *Desal. Water Treat.*, 53 (2015) 3170–3178.
- [4] F.J. García Latorre, S.O. Pérez Báez, A. Gómez Gotor, Energy performance of a reverse osmosis desalination plant operating with variable pressure and flow, *Desalination*, 366 (2015) 146–153.
- [5] J. Kherijl, A. Mnif, I. Bejaoui, B. Humrouni, Study of the influence of operating parameters on boron removal by a reverse osmosis membrane, *Desal. Water Treat.*, 56 (2015) 2653–2662.
- [6] J. Schallenberg-Rodríguez, J.M. Veza, A. Blanco-Marigorta, Energy efficiency and desalination in the Canary Islands, *Renew. Sustain. Energy Rev.*, 40 (2014) 741–748.
- [7] N. Dow, S. Gray, J. Li, J. Zhang, E. Ostarcevic, A. Liubinas, P. Atherton, G. Roeszler, A. Gibbs, M. Duke, Pilot trial of membrane distillation driven by low grade waste heat: Membrane fouling and energy assessment, *Desalination*, 391 (2016) 30–42.
- [8] N.M. Mazlan, D. Peshev, A.G. Livingston, Energy consumption for desalination – A comparison of forward osmosis with reverse osmosis, and the potential for perfect membranes, *Desalination*, 377 (2016) 138–151.
- [9] N.R.G. Walton, Electrical conductivity and total dissolved solids – what is their precise relationship? *Desalination*, 72 (1989) 275–292.
- [10] S. Boerlage, N. Nada, Algal toxin removal in seawater desalination processes, *Desal. Water Treat.*, 55 (2015) 2575–2593.
- [11] T. Bilstad, E. Protasova, A. Simonova, S. Stornes, I. Yuneizi, Wind-powered RO desalination, *Desal. Water Treat.*, 55 (2015) 3106–3110.
- [12] V. GnanaswarGude. Desalination and sustainability – An appraisal and current perspective, *Water Res.*, 89 (2016) 87–106.